

Vetina CS7

Veterinary 4K Rigid Endoscopy System

4K UHD Veterinary-Specific



Mindray Animal Medical Minimally Invasive Surgery Solution



Search Mindray Animal Medical

www.mindrayanimal.com
service@mindrayanimal.com

P/N:ENG-Vetina CS3-210285X8P-20210831

©2021 Shenzhen Mindray Animal Medical Technology Co., LTD. All rights reserved.

4K True Colors And Higher Resolution

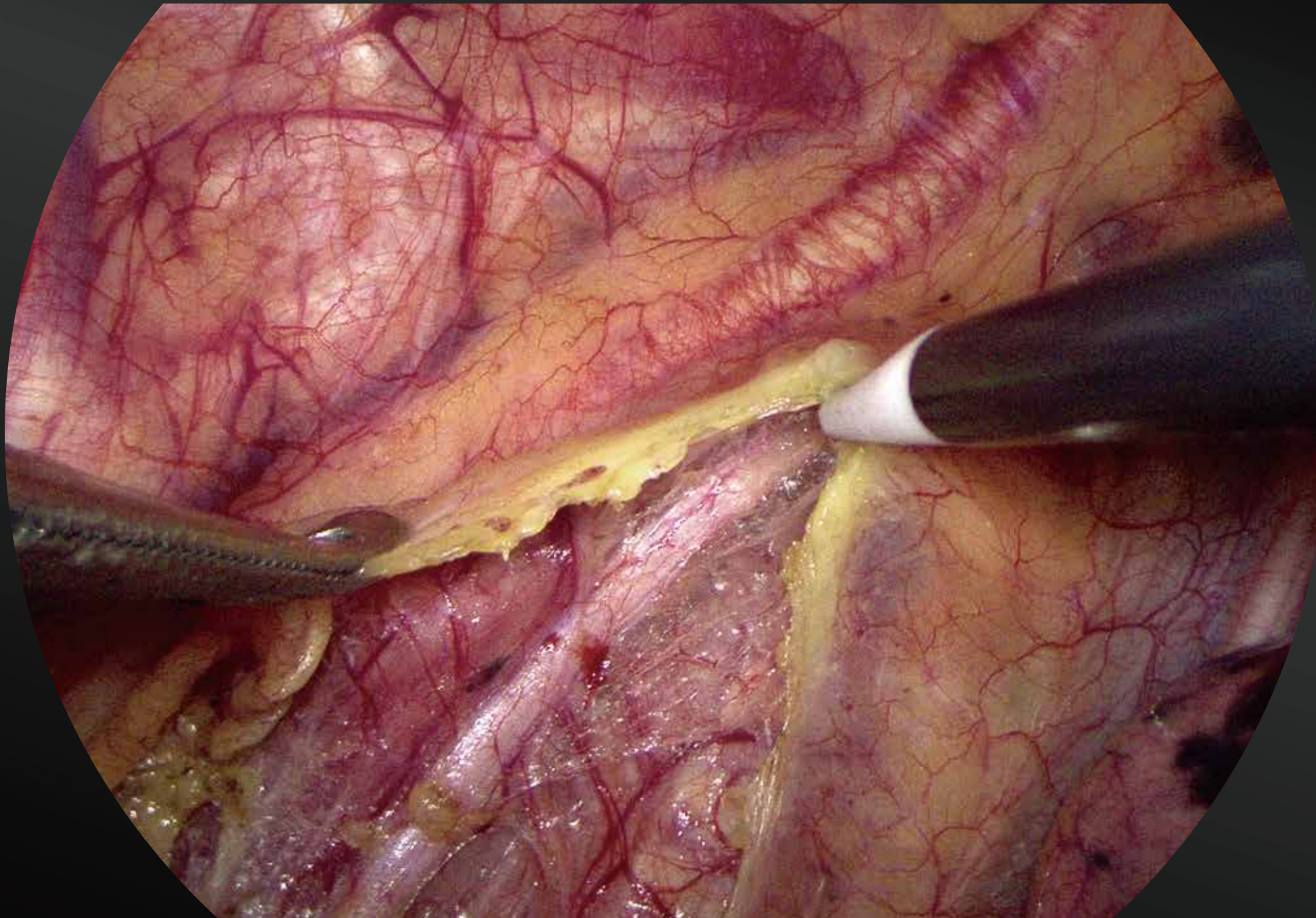

4K UHD Image

- 3840 × 2160 resolution; 4x the resolution of an HD image, with more vivid texture for accurate recognition

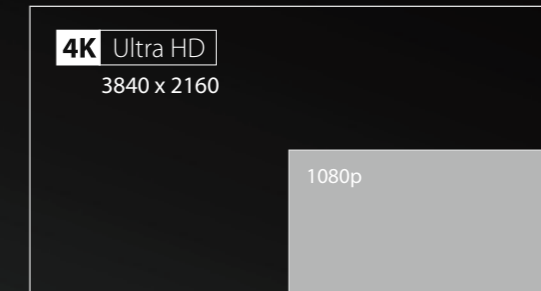

Wide Color Gamut

- Represents organs and tissues in real color, perfect identification of blood vessels, lymph nodes, and nerves.

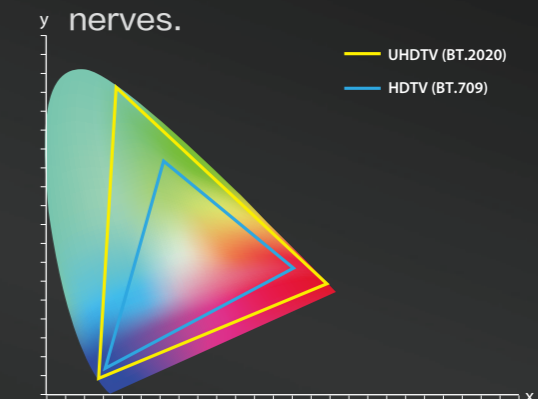

25–150mm Extended

- Focus remains clear while switching between multiple operating scenes.

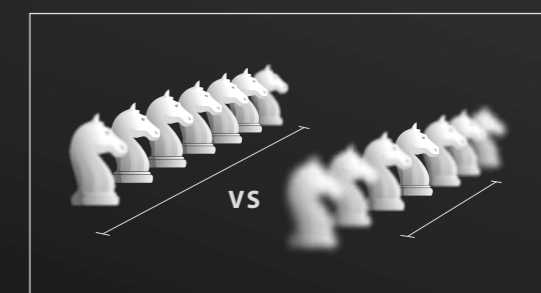

Sharpness near & far

55 " Immersive Experience



- Provide a better immersion experience
- Eliminate other interference
- Help surgeons improve concentration
- Bring an innovative operating experience
- Image can be enlarged 4 times without reducing the resolution
- Effectively reduces surgeon visual fatigue

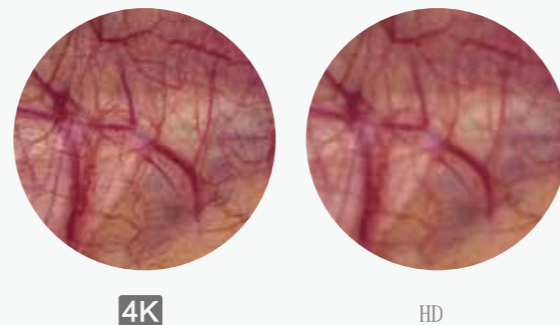
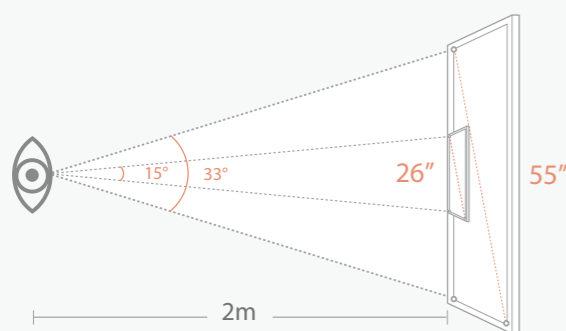

Built-in USB Recording



- UHD /FHD photo capture and video recording
- Easy recording with just one click
- With bookmark function, it is convenient for video record review and post-editing
- Convenient sharing and clear projection display on academic events
- Meets advertising demands of private animal hospitals

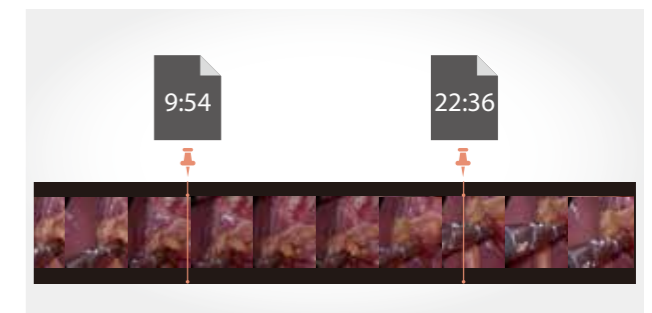

Ergonomics



- Trolley TITAN**
 - Support a 55-inch large screen
 - Four casters with brakes
 - The innovative structural design ensures convenient moving



- Cable Management**
 - The camera cup holder combined with the cable hook to prevent



- 7" Touch Panel**
 - The main functions are available with only one touch
 - 10° tilt up screen is easier for observation



Anti-Fogging HD Endoscope

* 25-150mm extended depth of field	Special anti-fog technique	Effectively avoids lens distortion	5mm,3mm Suitable for veterinary applications
--	----------------------------------	--	---



* Autoclaved
* Marked as LP5430M Endoscope parameters
LP530 Endoscope's depth of field is 10-100mm

4K Medical Grade Monitor

- 55" & 31" inch selectable
- IMAX in Operating Room
- Direct bonding Technology, Reduce reflection interference

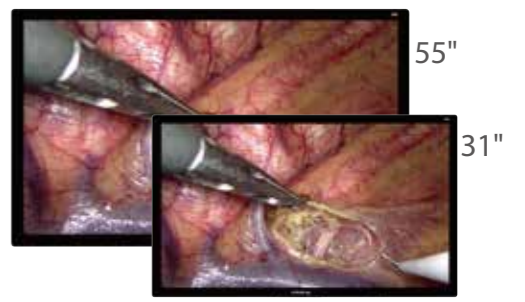

Veterinary Insufflator Vetina GS7

- Mindray's exclusive algorithm provides stable pressure
- Preset values specific for veterinary medicine
- Four insufflation modes available
- Gas heating to body temperature
- Smoke evacuation function



Veterinary Light Source Vetina LS7

- Comparable to the brightness of a xenon light source
- Long-term use to maintain low temperature
Service life of 30,000 surgeons

